



User Guide Standards

CONCERTO_ Driving Board



Table of Contents

Firmware Update SOP	1
1 Hardware Guide	1
(1) Hardware Requirements.....	1
(2) Hardware Installation	1
2 Software Guide.....	2
(1) Software Requirements	2
(2) Firmware Update by Application Software	2
Hardware Guide	6
1 Hardware Requirements.....	6
(1) Package Contents.....	6
2 Hardware Guide	8
(1) Hardware Requirements.....	8
(2) Demo Kit Hardware Description	9
3 Driving Board Function Block.....	9
4 Contact Information	10
5 Legal Information	10

Firmware Update SOP

1 Hardware Guide

(1) Hardware Requirements

The firmware update requirements included the CONCERTO driving board, micro-USB cable and Windows PC/NB.

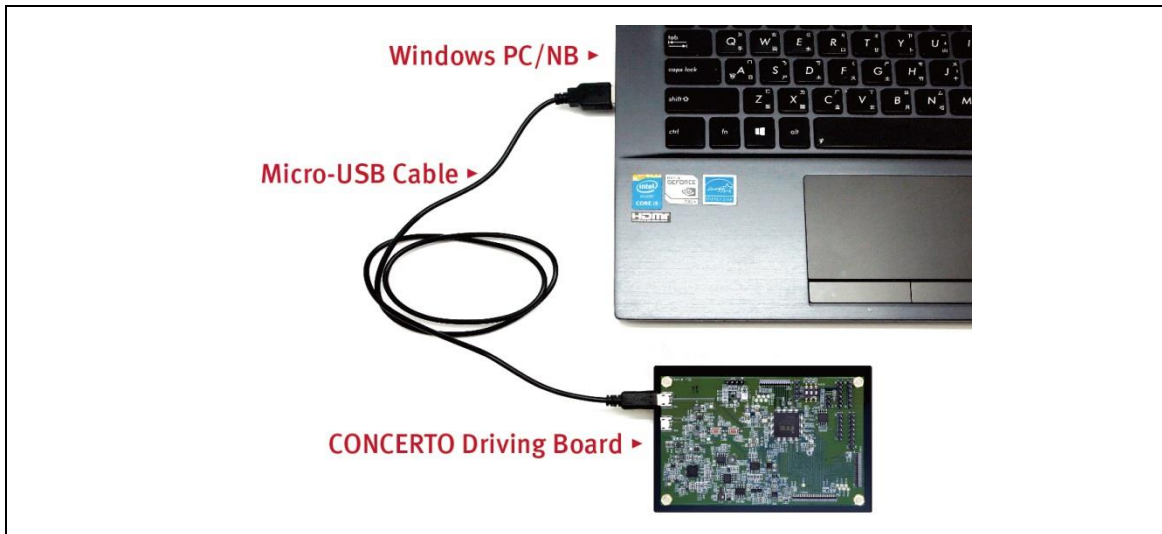

(2) Hardware Installation

Refer to following figure to setup CONCERTO driving board and connect it to your PC/NB:

- a Connect the micro-USB cable to CONCERTO driving board
- b Connect the micro-USB cable to PC/NB USB port

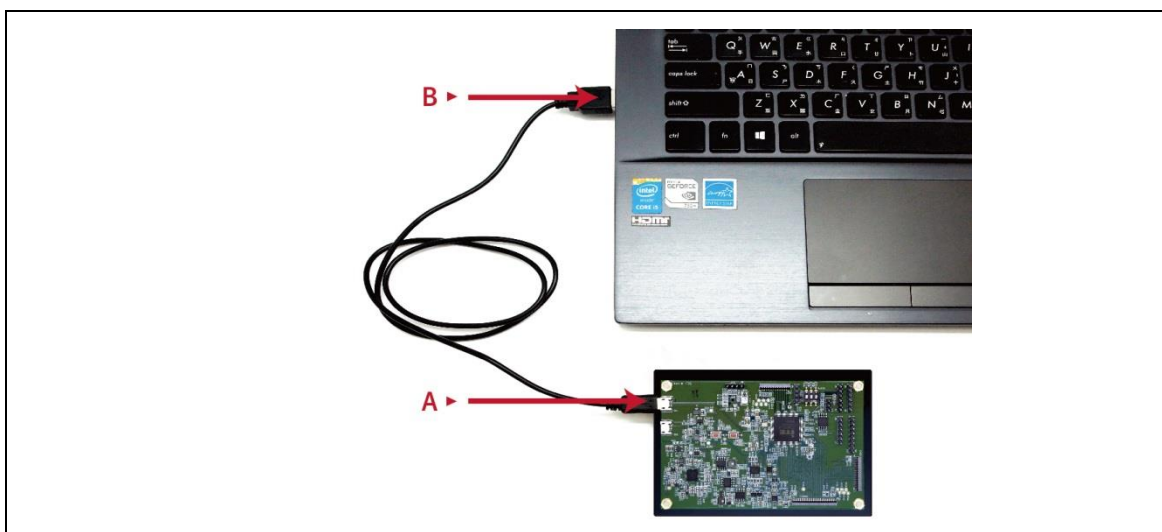

2 Software Guide

(1) Software Requirements

Application software ITE_TCon_DemoAP_v2.0.exe required.

Firmware required: Load the corresponding bin file of ePaper display.

Put the firmware with application software in the same folder.

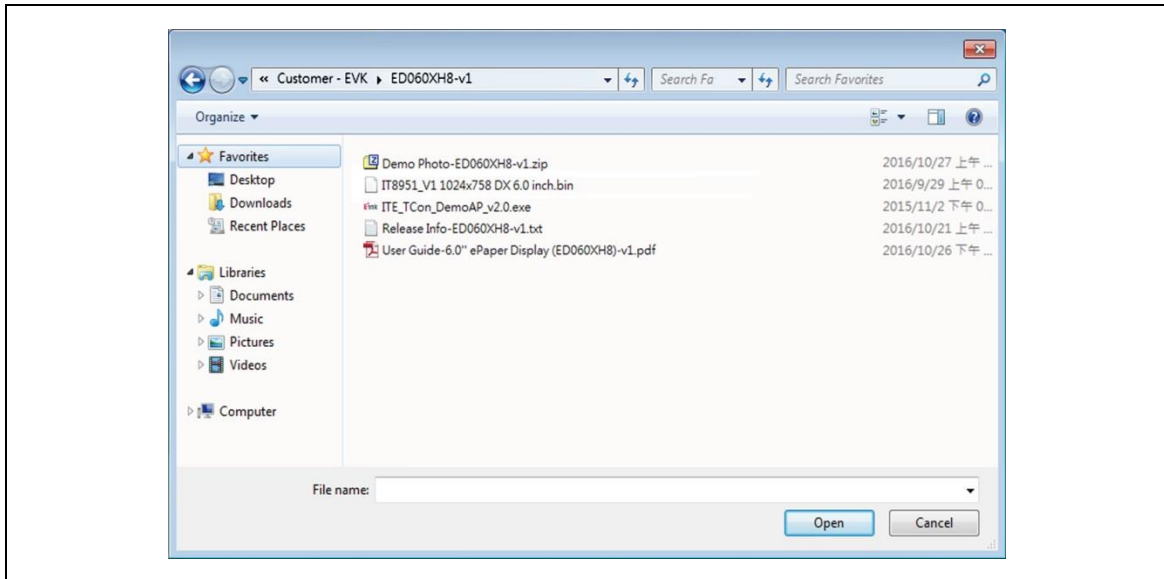

(2) Firmware Update by Application Software

● Press icon  ITE_TCon_DemoAP_v2.0.exe to open application software.

Click “connect” button to make sure the software has connected to physical drive.

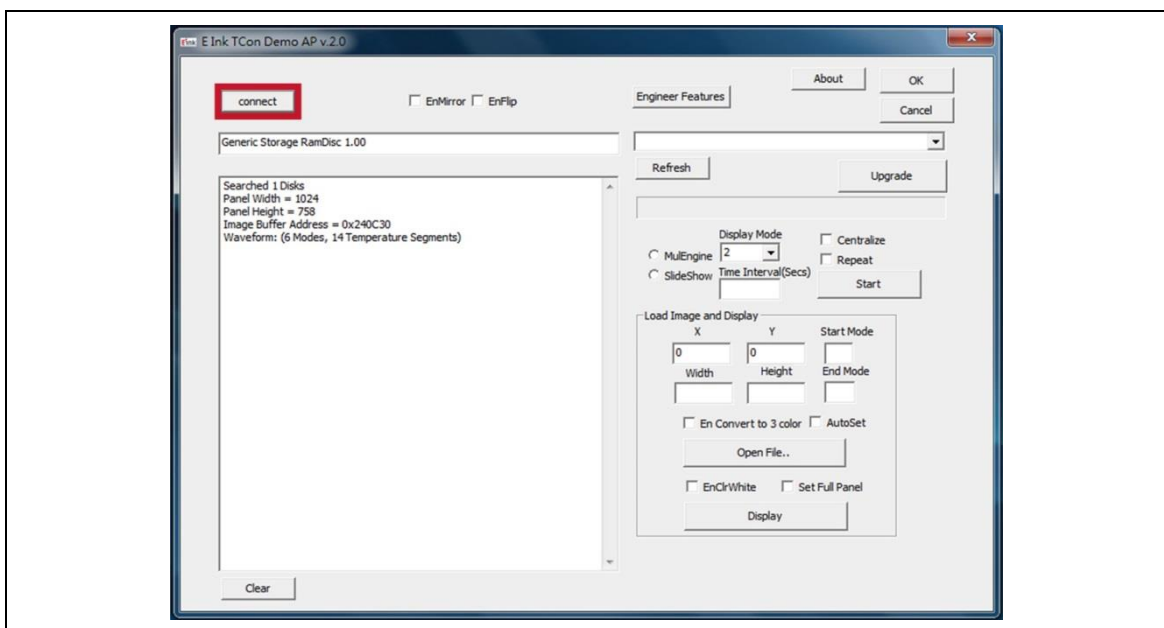

- Click “Refresh” and choose the firmware (bin file) option which you need to load:

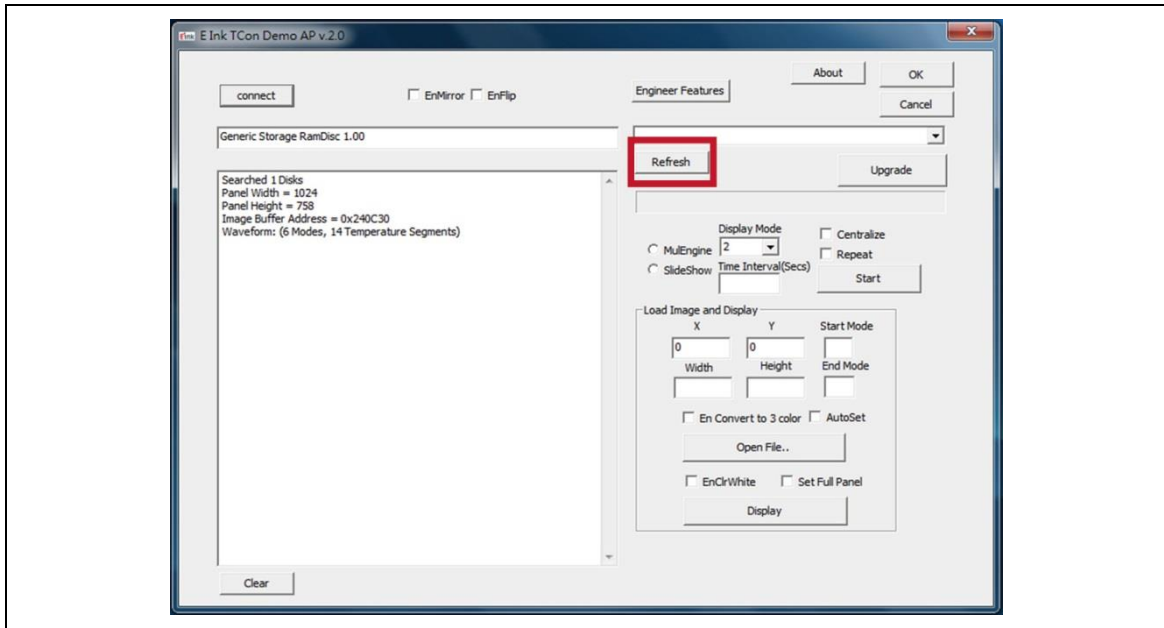

- Click “Upgrade” to load the firmware (bin file) to CONCERTO.

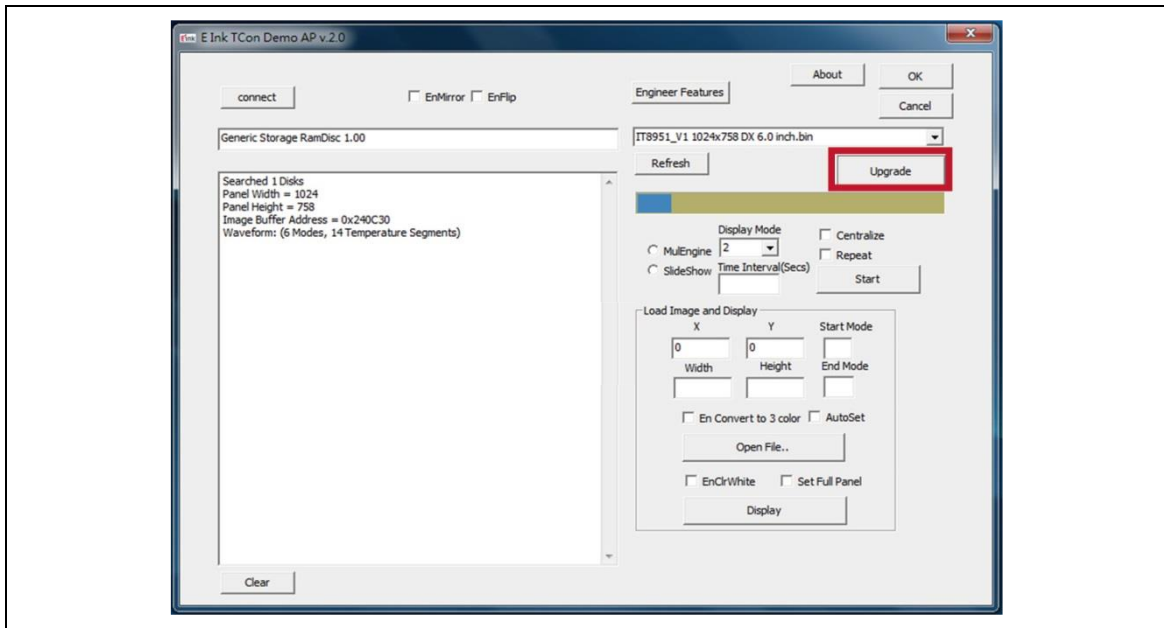

- Firmware (bin file) upgrade successful, click “OK” button.

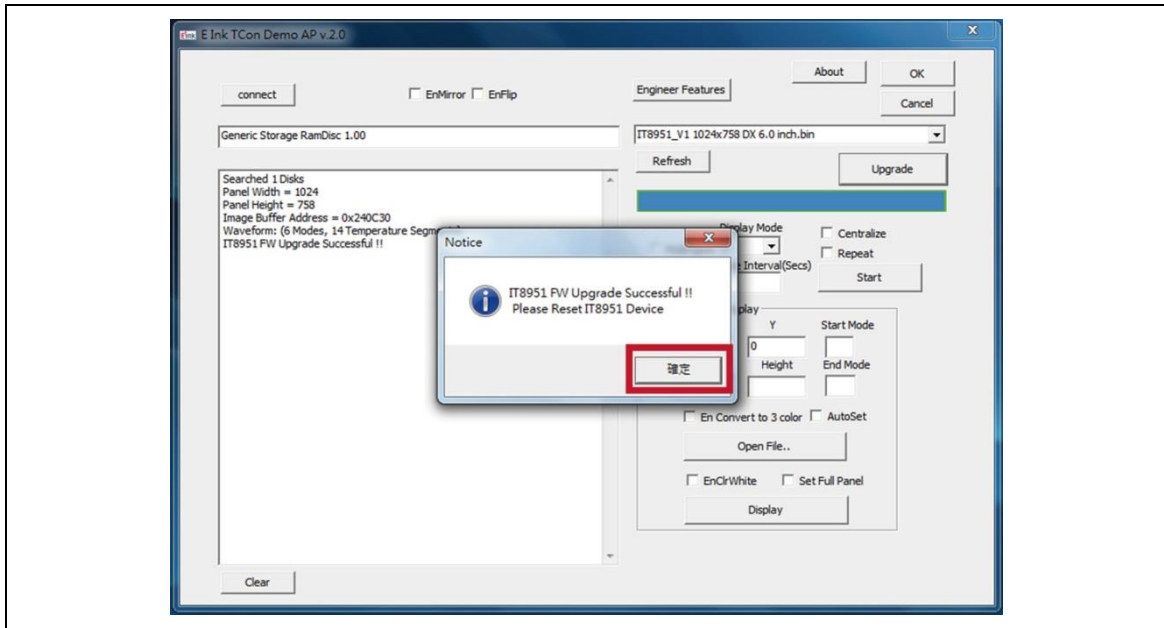

- Click “OK” button to close the application software.

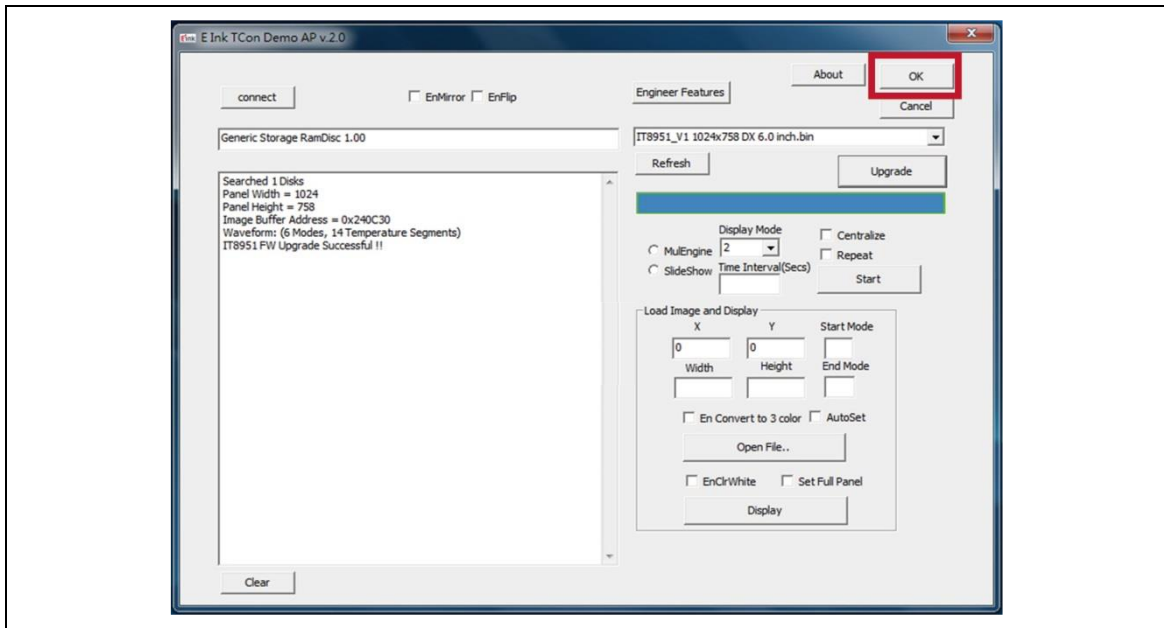

- Pull out the micro-USB cable, firmware update finished.

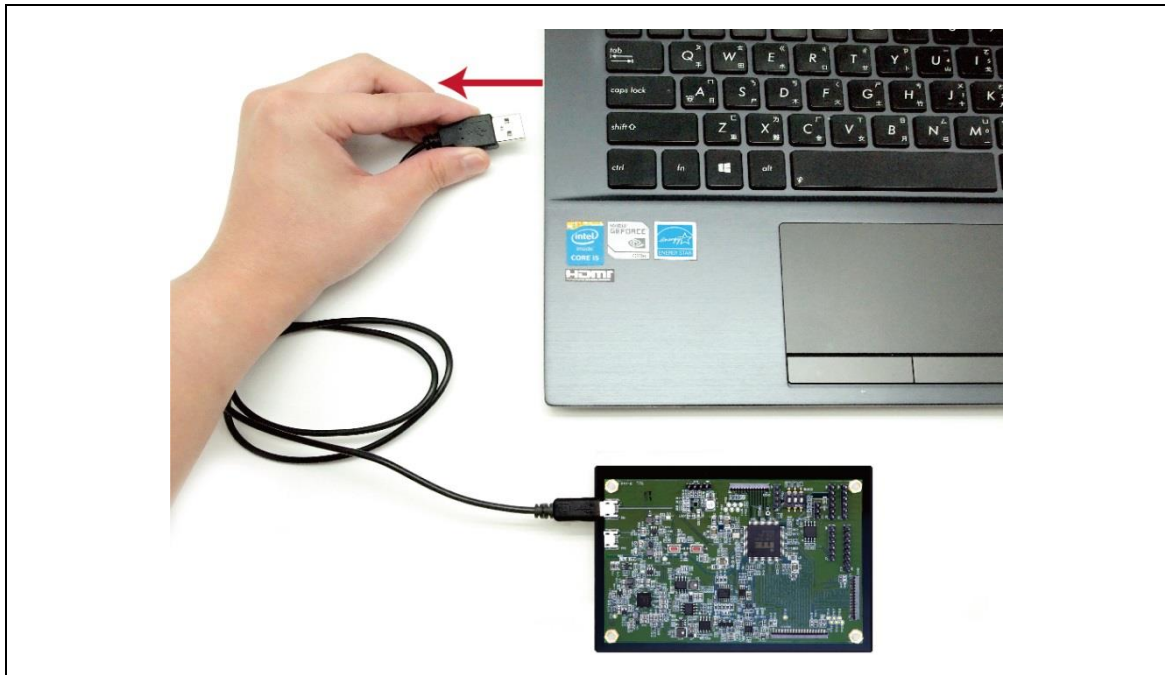

Hardware Guide

1 Hardware Requirements

E Ink's CONCERTO demo kit is intended to highlight the features and benefits of the ePaper display (EPD) display. This low power ePaper display uses E Ink technology which allows each pixel to show two color states – black and white. The CONCERTO demo kit is included the touch and front light function, which provides a multi-functional E Ink display reference design for customers. Users can easily demo the touch, front light and image update function on the touch screen of ePaper display.

Included in the CONCERTO demo kit is CONCERTO driving board, micro-USB cable, transfer boards, transfer cables and jumpers.

(1) Package Contents

This demo kit contains the following:

- CONCERTO Driving board
- Micro-USB cable
- Transfer board for touch
- Transfer board for front light
- 6 pins cable
- 4 pins cable
- Jumper (3 pcs)



CONCERTO Driving board



Micro-USB cable

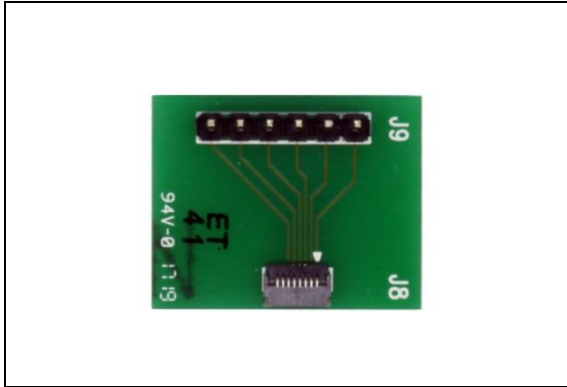

Transfer board for touch

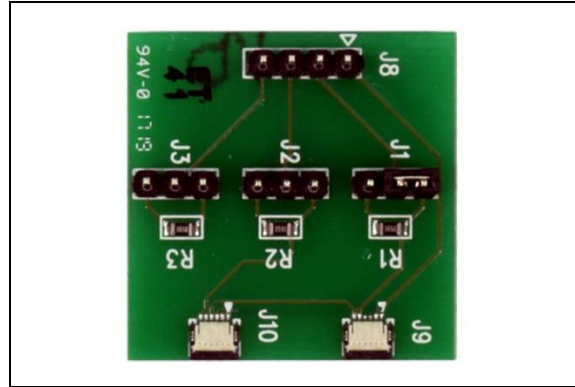

Transfer board for front light



6 pins cable



4 pins cable



Jumper (3 pcs)

Specification

Item	Specification
TCON	IT8951 DX
TCON Solution	Hardware TCON
LED Driving IC	LM3532
LED Driving Solution	I2C I/F control
Input	5Vdc (USB), power on when connected to PC

2 Hardware Guide

(1) Hardware Requirements



CONCERTO Driving Board



Micro USB cable



Windows PC/NB

Table 1 Minimum PC Requirements

CPU	Pentium III 800 MHz or later
RAM	128MB or greater
Required Software	Windows 7 or newer
Interface	USB port

(2) Demo Kit Hardware Description

The CONCERTO demo kit includes a CONCERTO driving board. The CONCERTO driving board (connector 2 or connector 402) and E Ink ePaper display (EPD) panel are connected via a corresponding FPC adapter (ED060XH8 is not required). The demo kit is included the touch (connector J7) and front light (connector J13) function. The micro USB port on the demo kit supplies power and data to CONCERTO driving board and E Ink panel. Users can easily demo the touch, front light and image update function on the touch screen of ePaper display. Furthermore, using the E Ink PC application, users can send customized image data to the board or update settings.

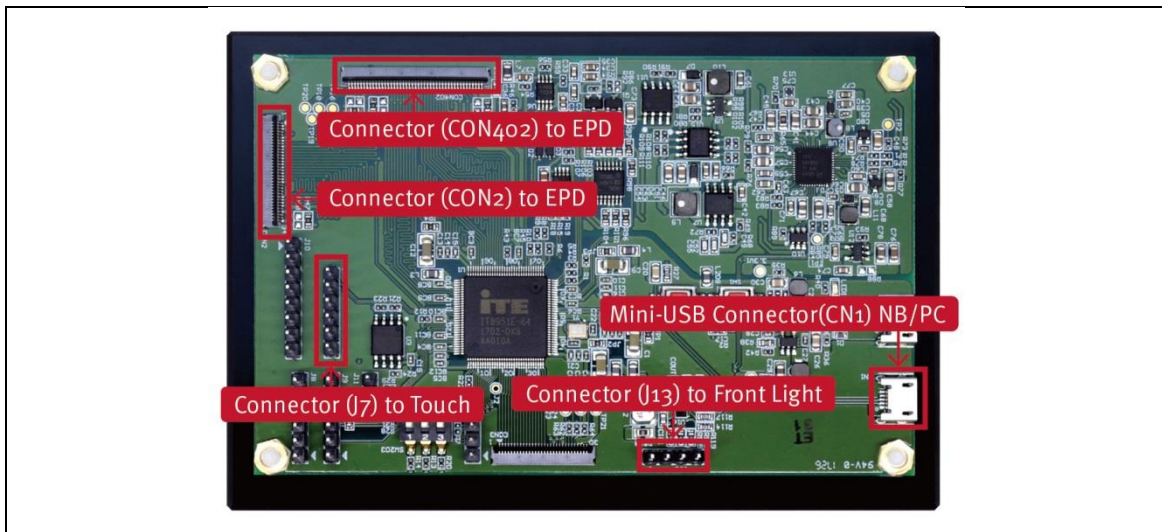
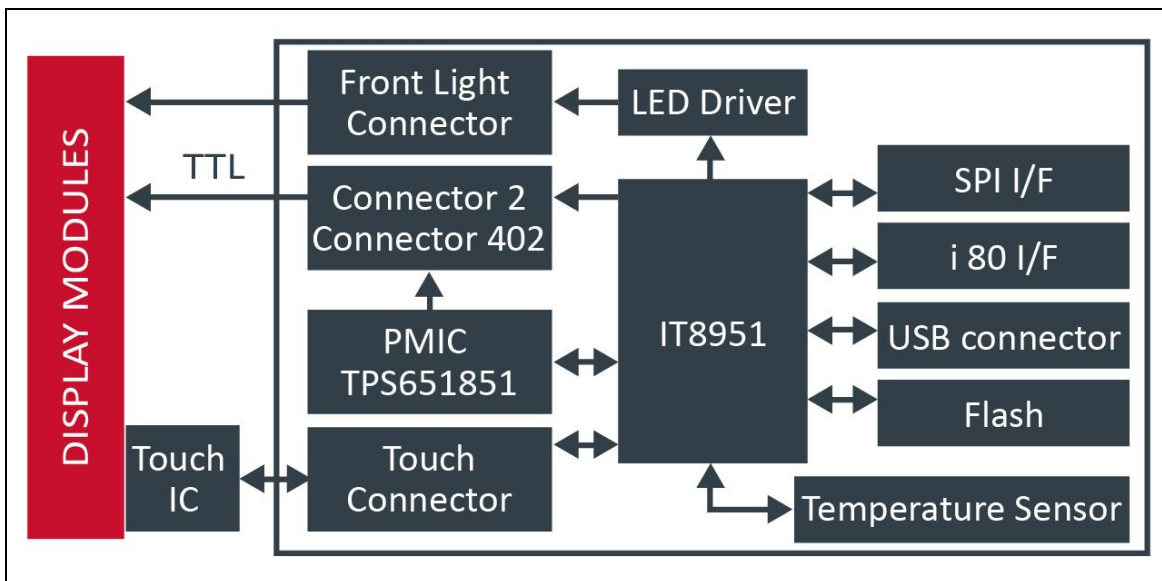

Figure 2 CONCERTO driving board function

3 Driving Board Function Block



4 Contact Information

For more information, please visit

<http://www.eink.com>

For sales office addresses, please visit

http://www.eink.com/contact_sales.html

5 Legal Information

● Definitions

The document is a draft version only. The content is still under internal review and subject to formal approval which may result in modifications or additions. E Ink does not give any representations or warranties as to the accuracy or completeness of information included herein and shall have no liability for the consequences of use of such information.

● Right to make changes

E Ink reserves the right to make changes to information published in this document, including without limitation specifications and product descriptions, at any time and without notice.

● Suitability for use

Products described in this document are intended for development purposes only and comes without any warranty. E Ink accepts no liability for inclusion and/or use of E Ink products in commercial products or applications and therefore such inclusion and/or use is at the customer's own risk. In no event shall E Ink be liable for any direct, indirect, incidental, special, exemplary, or consequential damages (including, but not limited to, procurement of substitute goods or services; loss of use, data, or profits; or business interruption) however caused and on any theory of liability, arising in any way out of the use of the software.

● Applications

Applications that are described herein for any of these products are for illustrative purposes only. E Ink makes no representation or warranty that such applications will

be suitable for the specified use without further testing or modification.

- No offer to sell or license

Nothing in this document may be interpreted or construed as an offer to sell products that is open for acceptance or the grant, conveyance or implication of any license under any copyrights, patents or other industrial or intellectual property rights.

- Trademarks

Notice: All referenced brands, product names, service names, and trademarks are the property of their respective owners.

- Revision History

Version	Date	Page	Description	Author
0.1	2017/8/1		Initial	Joseph Wu